

Sávcsók

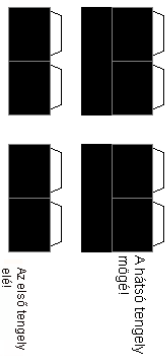

Olvasd el a ragasztási tanácsokat is!

A pótkerekeket 2 oldalról ragaszd össze egymással, a piros vonallal jelzett helyen. Utána ragaszd fel a rövid oldalt az alváz alá, a hosszabbik oldalt, pedig a plató alá! Után a rakót rájuk a pótkerekeket!

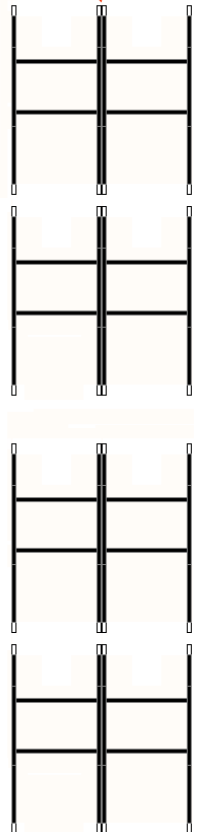

D pótkerekeket
D pótkerekeket
D pótkerekeket
D pótkerekeket

Készítette: Thold Tamás (Maketissimo)
www.papimakert.hu
papimakert@gmail.hu

A hídakat ragaszd a kerekre
belsőjelelvő számmal

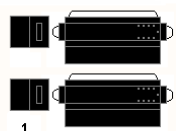
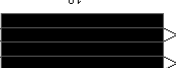

A kitémasztólábakat ragaszd össze, ragaszd rájuk a talpukat, és ragaszd a helyükre!

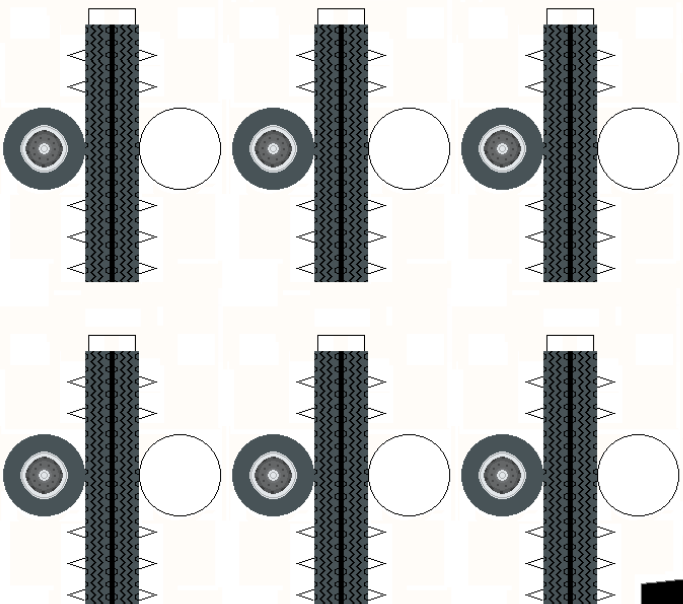
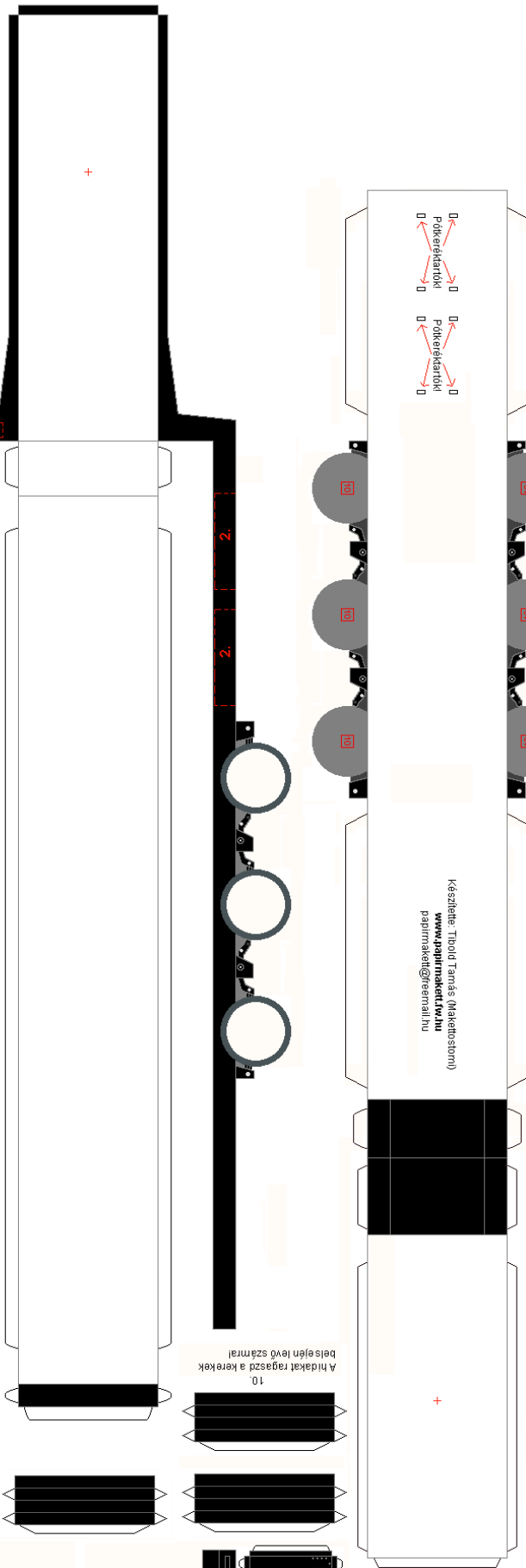

4 pótkereket

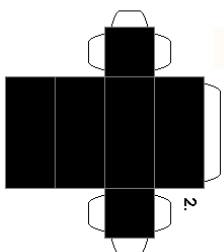
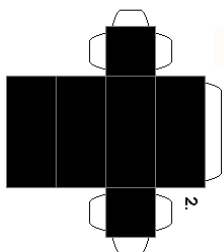
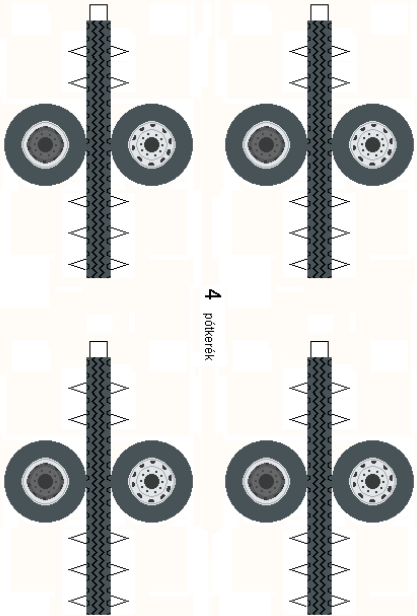

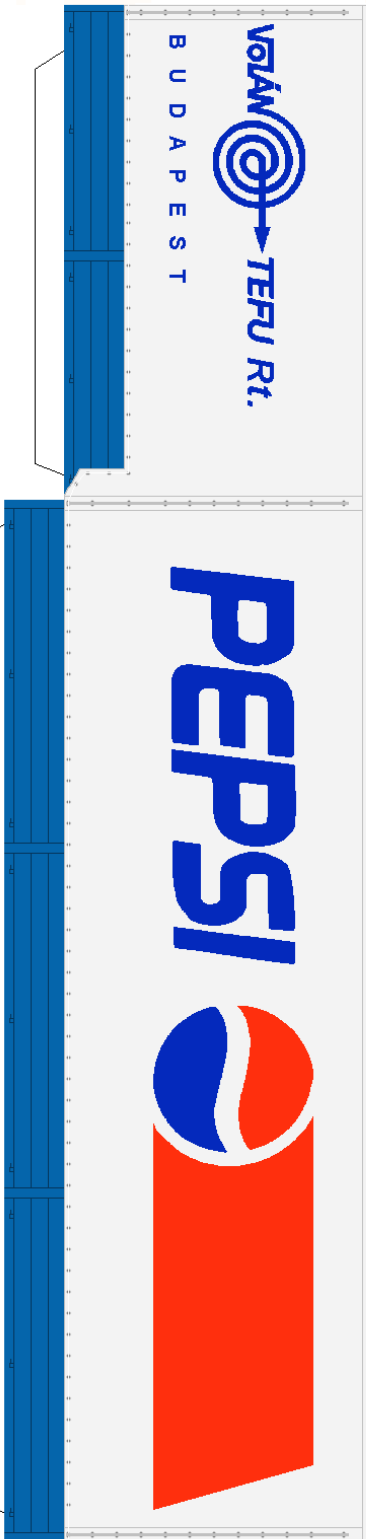
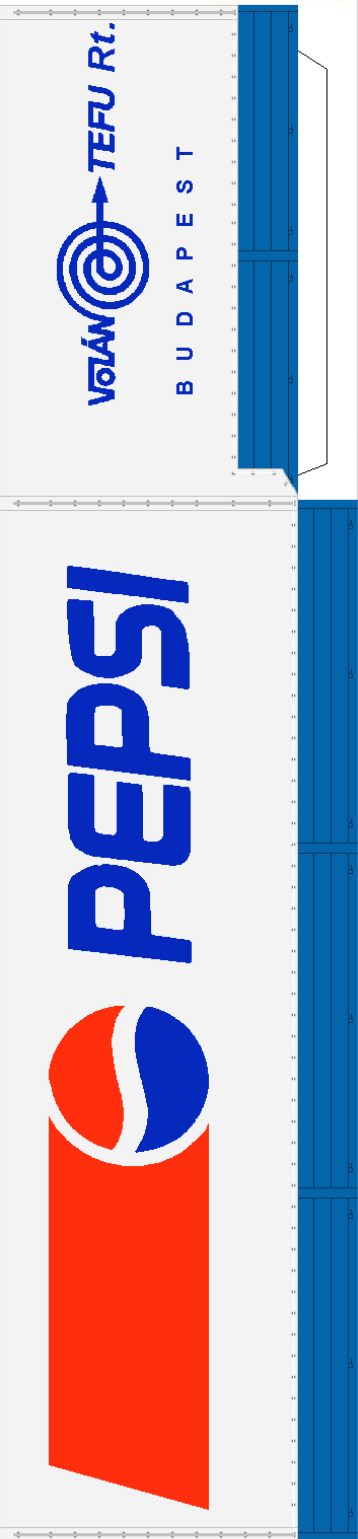
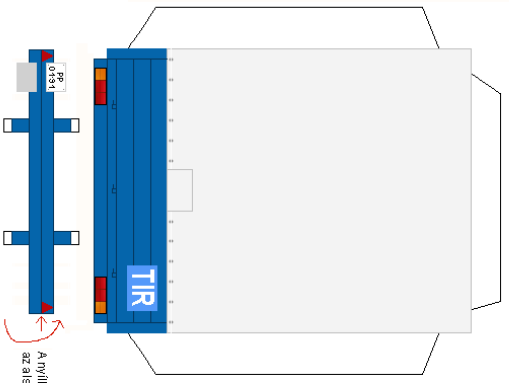
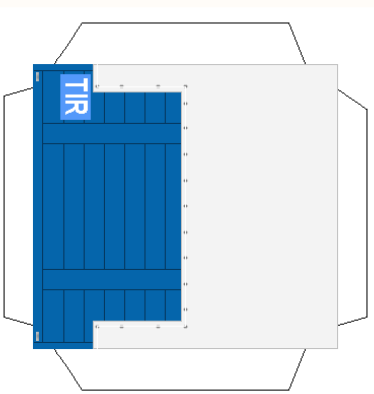
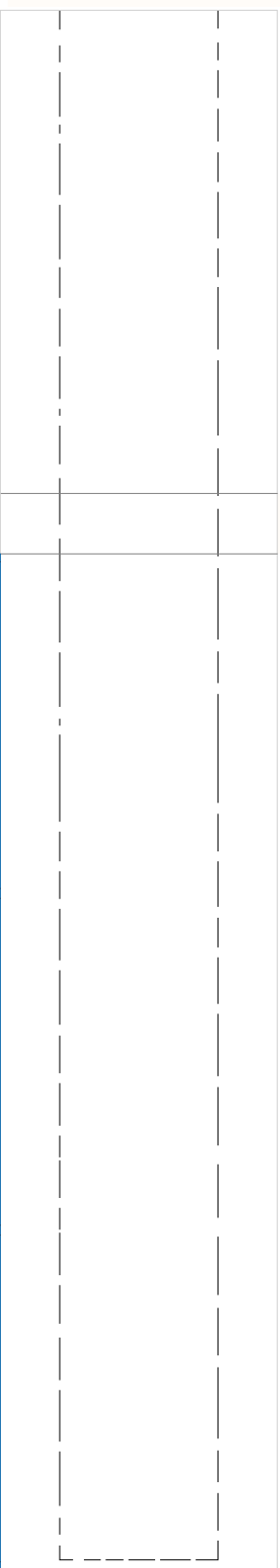

A nyíljal jelzett vonal mentén hajtsd vissza
sz. 0180 / 05281