

Az előshídat ragaszd az első kerékek belső felén lévő piros lejtájakra!

Olvasd el a ragasztási tanácsokat is!

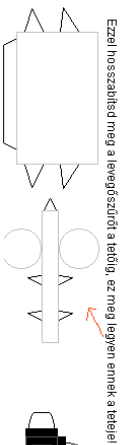

Ezekből csinálj 6y fekete alakra, és ragasd a nyílra jelzett helyre! Felragasztani nem fontos, mert alapban megvan rajzola.

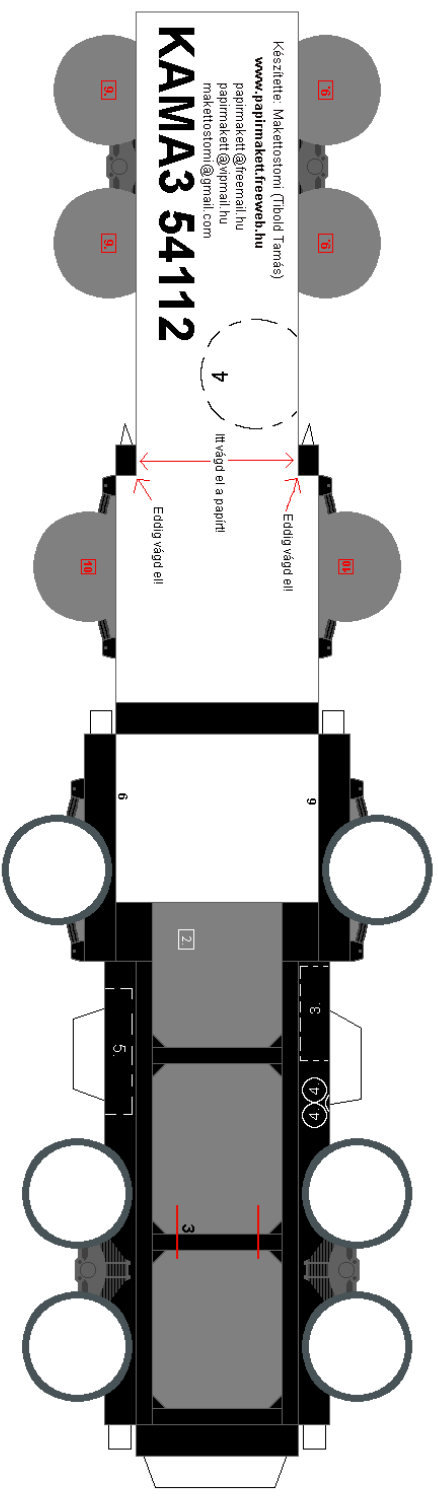
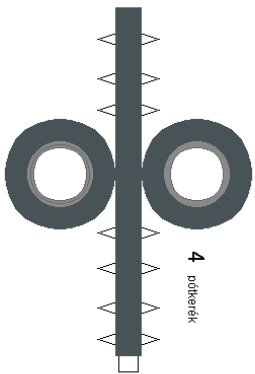
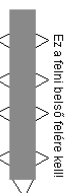
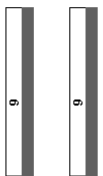
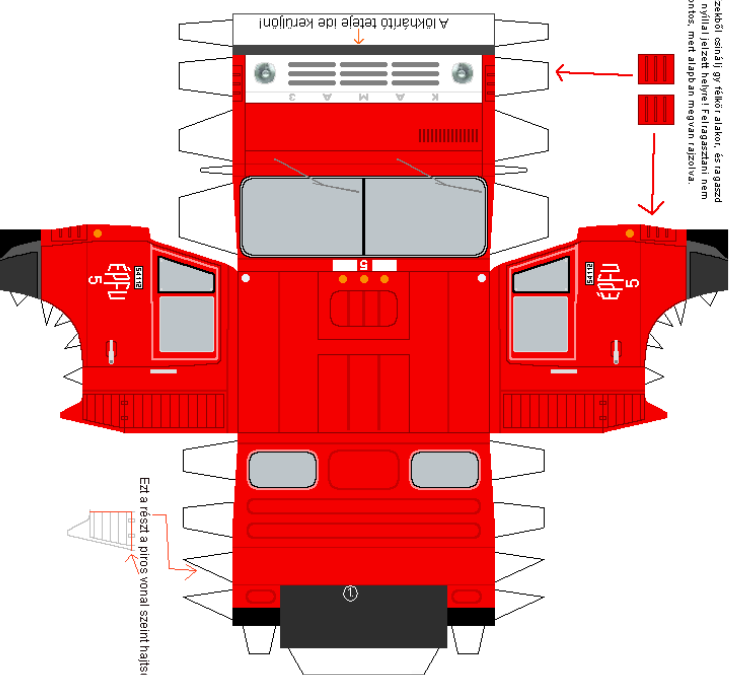

Ezt a részt a piros vonal színt haltsd meg!

A ragasztóú tétele, a vágó tételeivel legyen egyvonalban!

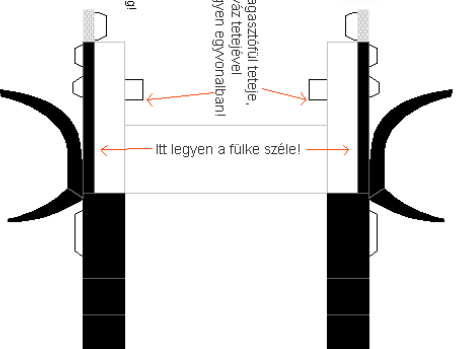

Légszűrő talpa

Légszűrő

Légszűrő teteje

2.

