

2

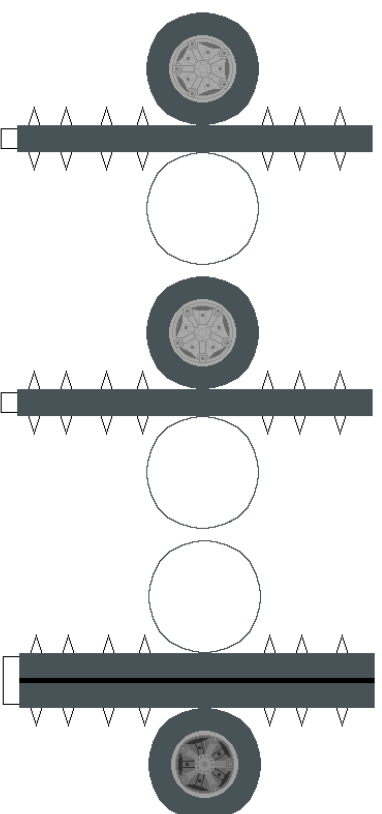

A segédalkatrészeket ragaszd az alváz szélével. Először a torvondatkeresztbe, előre a felépítmény elejétől kezdve, vonalra, és hátra a víz végéig, utána a hosszúkat ragaszd közülük hossz irányban!

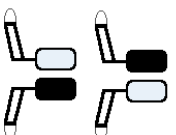
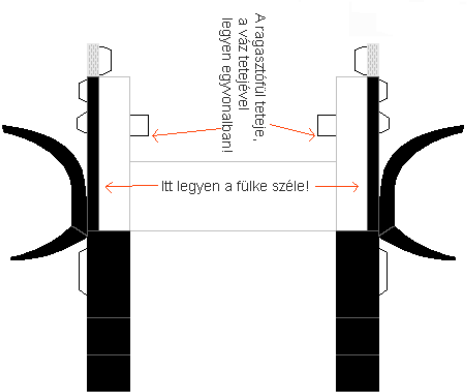
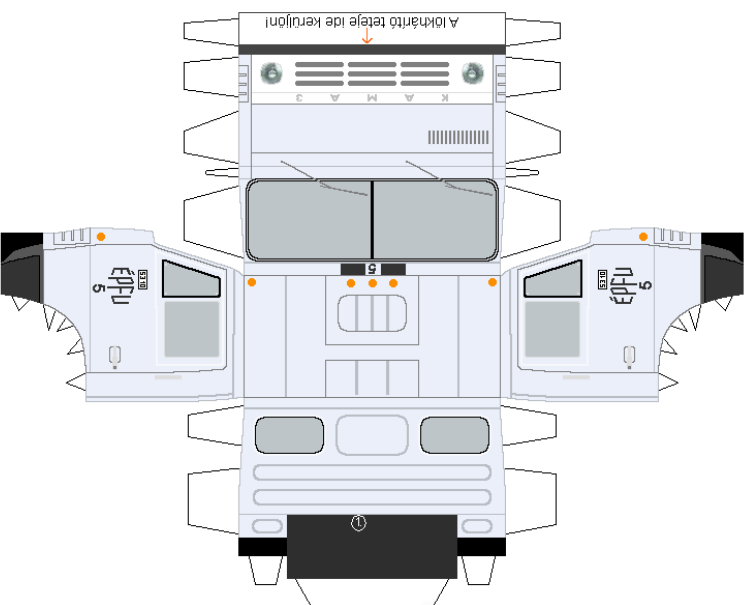
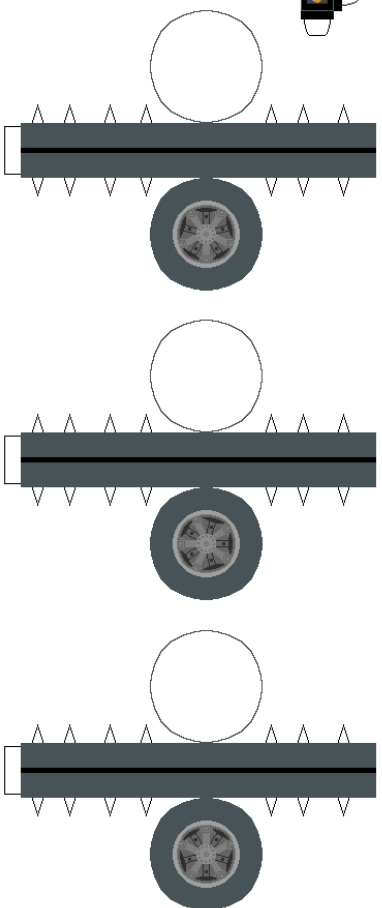
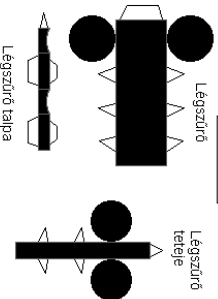
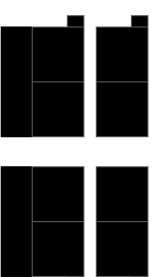
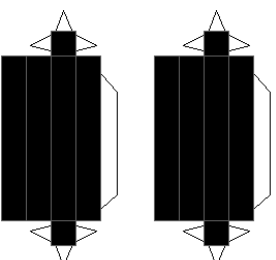
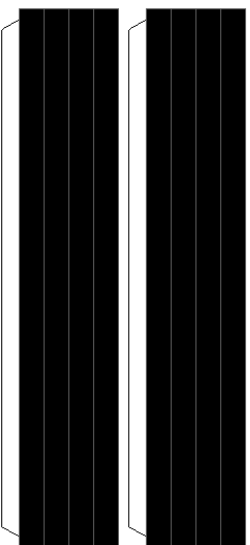
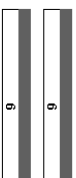

Sarvedők: reisd a központi tengely elé, az alsó a hátsó tengely mögött!

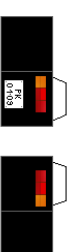

Ezeket a felépítményjára ragaszd a végül párt-m-el beljebb!

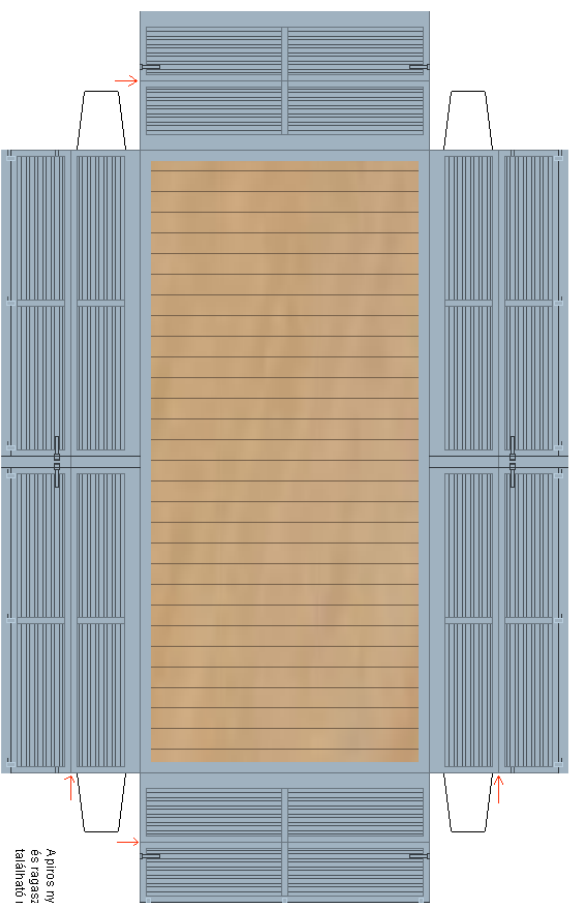
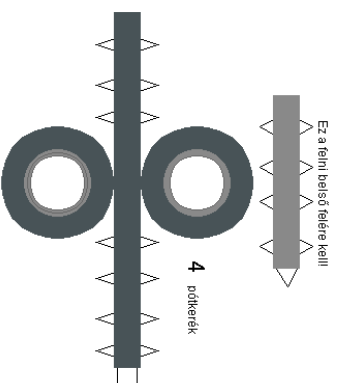
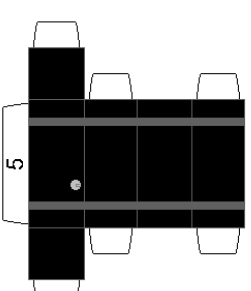
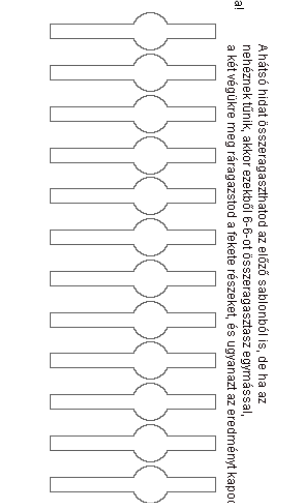
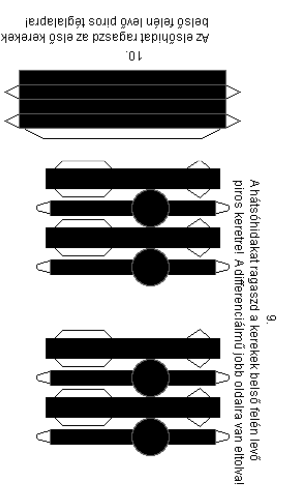
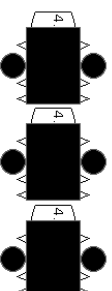
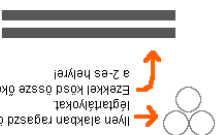
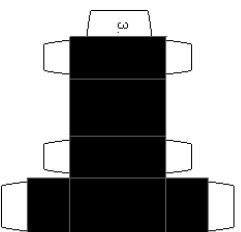

A piros nyílakkal található vonal mentén hajtsd össze az oldalakat, és ragaszd össze öklel. Perzd az elejét, és a hátulját az oldalt található ragasztófelület is ragaszd közél!