

Olvasd el a ragasztási tanácsokat is!

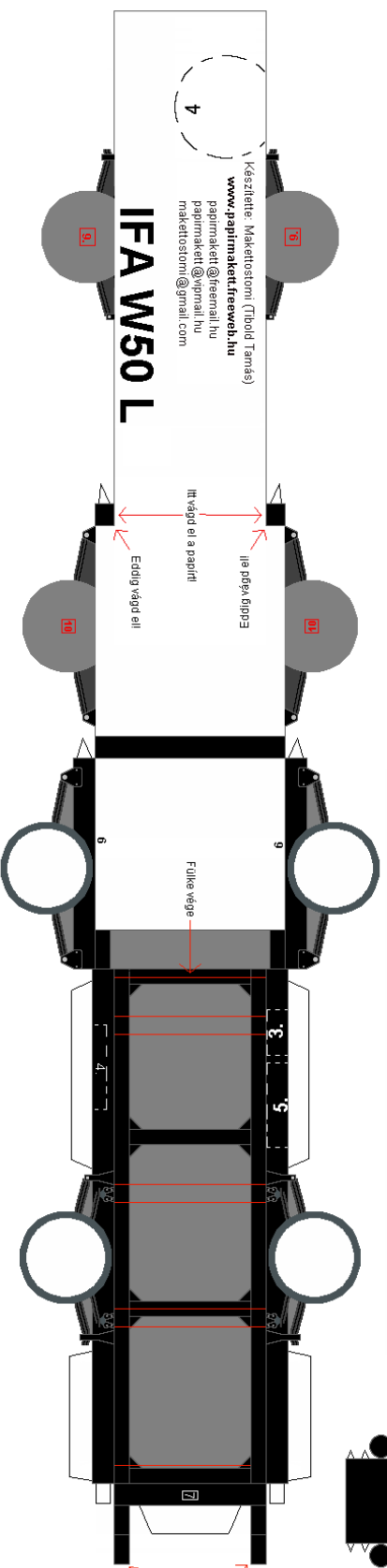

A vonalakat mentén, de kell vágdosni!

A sárvédőket közepesen hajtsd össze, és formázz belőlük félkört, ezután ragaszd a kerékhöz!

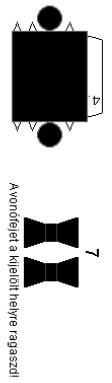
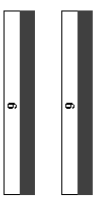
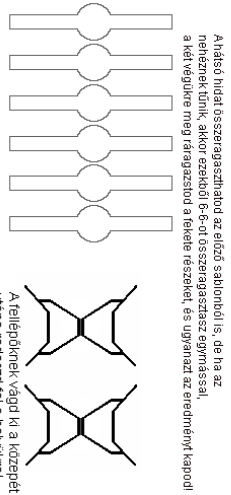
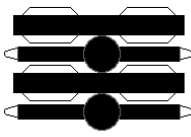
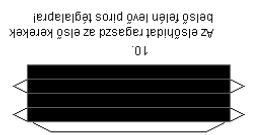
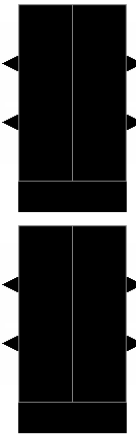
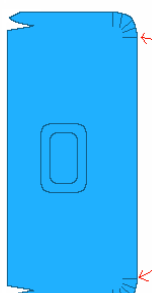

A fellegbúknak vágd ki a közepét is, utána radszod fel a helyükre!

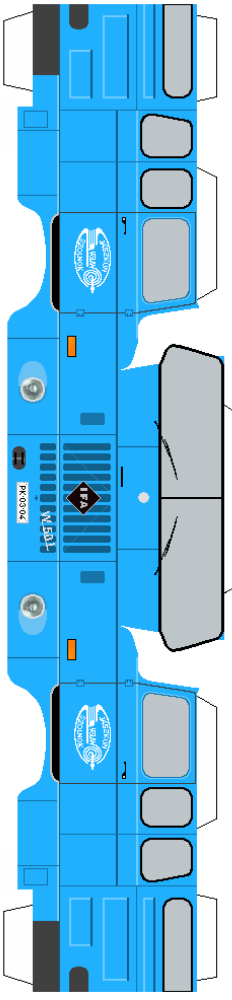

4 potkerek

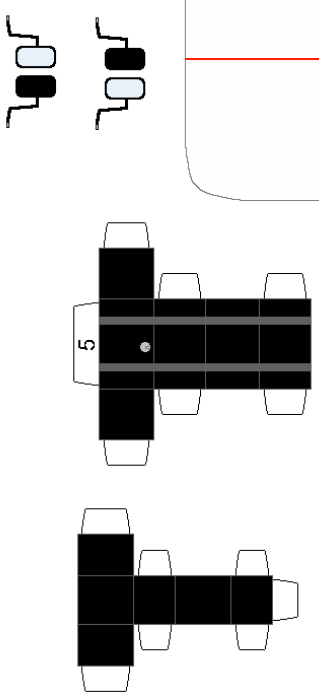
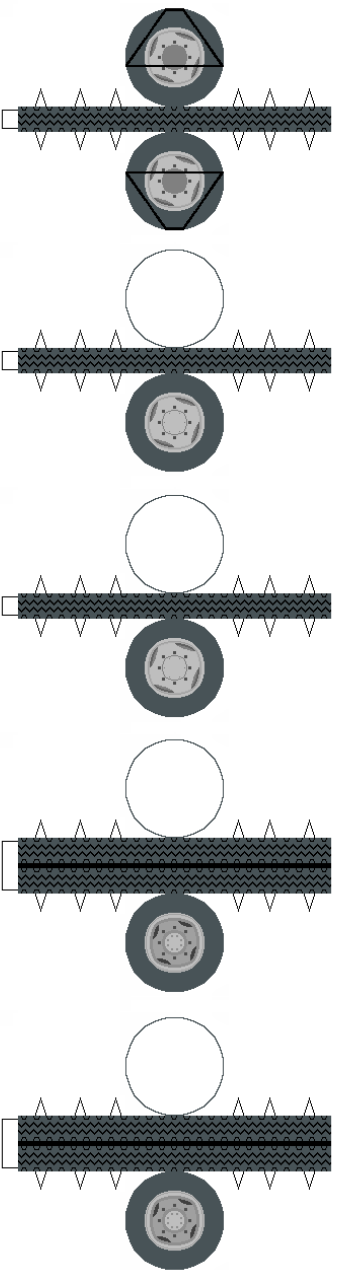

A segédvázakat ragaszd, az alvázon található,
piros vonalakra!

